

Spare parts list for RPMT520 engine			
Pozice	Obj.číslo	Popis	Množství
1	BZ4AE08	Nut/Gb/T41-2000	1
2	BZ3HJEO0825	Bolt	2
3	BZ5CD1015	Washer/Gb7425-1987	2
4	2BC06910800	Shoe Clutch	2
5	BZ5AE081615	Washer/Gb/T97.1-2002	2
6	BZ3GJCM0525	Bolt/Gb/T70.1-2000	4
7	2BC12010102	Cover	1
8	2BC12080602	Rotor	1
9	BZ8BE301507	Oil Seal $\Phi 30 * \Phi 15 * 7$	1
10	2BC12910700	Lever Choke	1
11	2BC12910700	Body Assy	1
12	2BC12910700	Plate	1
13	BZ3GJEO0555	Screw/Gb/T70.1-2000	2
14	2BC12910700	Element	1
15	2BC12910700	Plate	1
16	2BC12910700	Cover Assy	1
17	BZ3BJCM0516	Screw/Gb/T818-2000	1
18	BZ9BA130305	Key/Gb1099-1979	1
19	2BC12010205	Crankcase Left	1
20	BZ1CA000510	Pin/Gb/T119.1-2000	2
21	BZ7AF6202	Bearing/Gb/T276-1994	1
22	2BC12022101	Pin	1
23	2BC12081901	Ring	2
24	2BC12080101	Piston	1
25	BZ7CH101416	Bearing/Jb/T7918-1997	1
26	2BC12021401	Ring	2
27	2BC12910300	Crank Shaft	1
28	BZ8BE221207	Oil Seal $\Phi 12 * \Phi 22 * 7$	1
29	2BC12081801	Gasket Case	1
30	2BC12010206	Crankcase Right	1
31	BZ3GJEO0535	Screw/Gb/T70.1-2000	4
32	BZ5BC0813	Washer/Gb93-1987	2
33	2BC06020401	Fulley	1
34	2BC06021501	Gasket	1
35	2BC06910400	Reciol Assy	1
36	BZ3GJCM0520	Screw/Gb/T70.1-2000	4
37	BZ3BJCM0516	Screw/Gb/T818-2000	1
38	BZ3GJEN0655	Bolt/Gb/T70.1-2000	2
39	2BC12081401	Muffler Assy	1
40	2BC12081805	Plate	1
41	2BC12081802	Gasket Base	1
42	BZ3GJEO0520	Bolt/Gb/T70.1-2000	4
43	2BC12081804	Plate	1
44	2BC12080301	Carburetor	1

Spare parts list for RPMT520 engine			
45	2BC06080701	Spark Plug	1
46	2BC12080202	Cylinder	1
47	2BC12081803	Gasket Insulator	1
48	2BC12001701	Insulator	1
49	BZ3GJEN0530	Screw/Gb/T70.1-2000	2
50	2BC12080802	Coil Ass'Y	1
51	BZ3GJCM0520	Screw/Gb/T70.1-2000	2
52	BZ3CJCM0516	Screw	1
53	2BC12000102	Top Cover	1
53-1	2BC12000105	Plate,Top Cover	1
54	2BC06910800	Clutch Spring	1
55	BZ3GJCM0520	Screw/Gb/T70.1-2000	2
56	2BC12001501	Oiler	1
57	2BC06070304	Oil Pot Rubber Shock	1
58	2BC06020306	Oil Pot Linking Piece	1
59	32BAR65	Fuel Filter	1
60	3B55A46	Fuel Piee	2
61	2BD6456	Pipe Base	1
62	2BDV253	Anti-Swap Board	1
63	2BV5532	Aprons Sealed	1
64	2B645692	Anti-Block Off Plate	1
65	2B986550	Check Valve	1
66	2BM9833	Filter Screen	1
67	2B689955	Oiler Cover	1

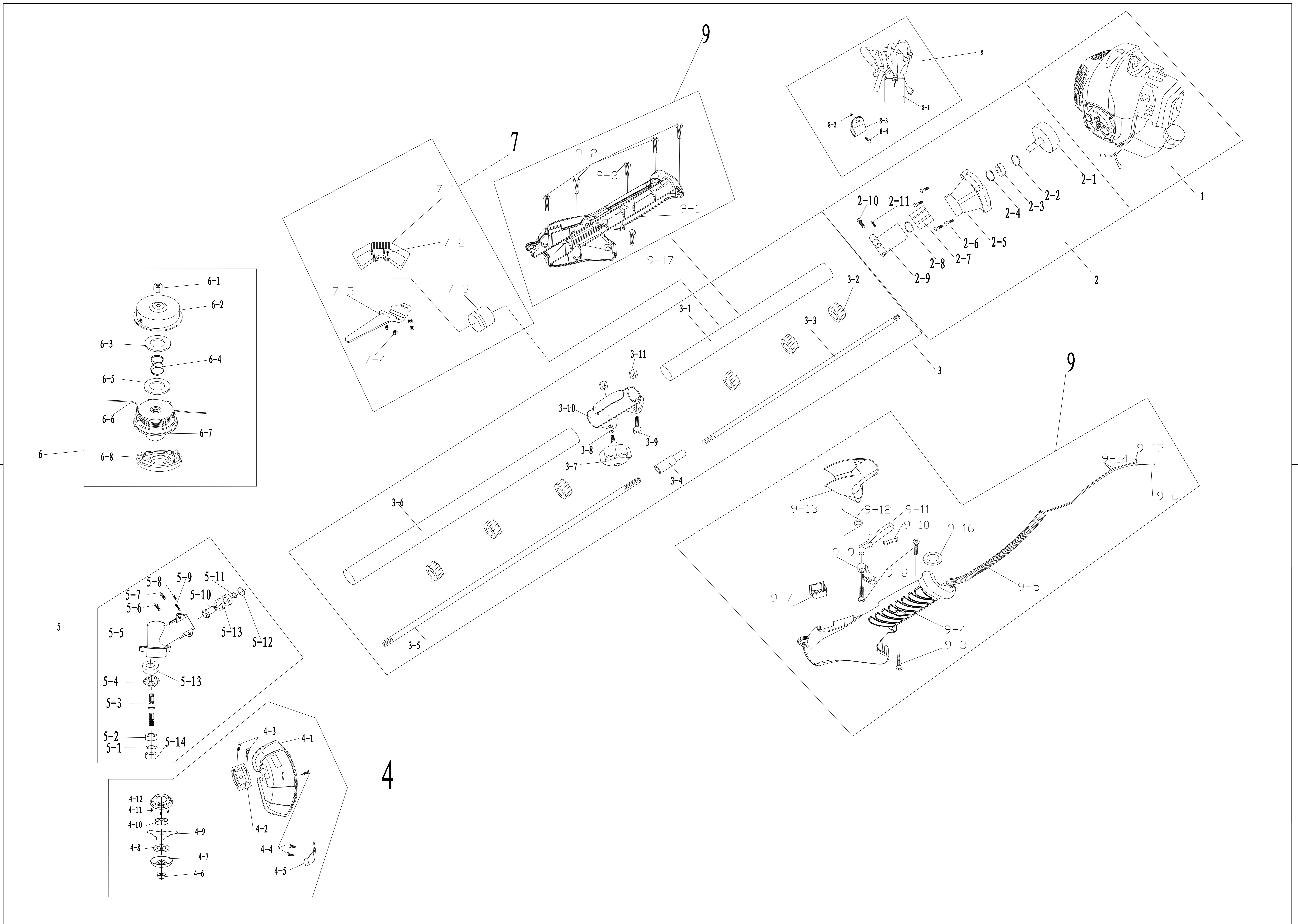

Spare parts list for RPMT520 Transmission			
Pozice	Obj.číslo	Popis	Množství
1	WL520B	Engine	1
2	2BD523565412	Hosing Assy	1
2-1	2BC06020402	Drum	1
2-2	BZ6AE35	Snap Ring \varnothing 35 /Gb/T893.1-1986	1
2-3	BZ7AE6202RS	Bearing 6202Rs /Gb/T276-1994	1
2-4	BZ6BE15	Snap Ring \varnothing 15 /Gb/T894.1-1986	1
2-5	2BC06011501	Hosing	1
2-6	BZ3GJCM0630	Bolt M6X30 /Gb/T70.1-2000	4
2-7	2BC06070302	Cushion	1
2-8	BZ6AE45	Snap Ring \varnothing 45 /Gb/T893.1-1986	1
2-9	2BC06010504	Bracket	1
2-10	BZ3GJCM0625	Bolt M6X25 /Gb/T70.1-2000	1
2-11	BZ3GJCM0616	Bolt M6X16 /Gb/T70.1-2000	1
3	2BCDR48626	Transmission pipe assy	1
3-1	2BC06010502	Pipe one	1
3-2	2BC07021701	Oil bearing	6
3-3	2BC06020102	Transmission shaft one	1
3-4	2BC07020104	Connector	1
3-5	2BC07020103	Working transmission shaft two	1
3-6	2BC07010502	Working transmission pipe two	1
3-7	2BC02000301	Knob	1
3-8	BZ5AE06-12	Washer	1
3-9	BZ3GJE00618	Inner Screw M6X18 /Gb/T70.1-2000	1
3-10	2BC02010503	Pipe connect sheath	1
3-11	BZ4CB06	Nut M6 /Gb/889.2-2000	1
4	2BDC1565RA	Guard Assy	1
4-1	2BC07001401	Guard	1
4-2	2BC06020310	Bracket	1
4-3	BZ3GJCM0620	Bolt M6*20 /Gb/T70.1-2000	1
4-4	BZ3BZEV0414	Screw /Gb845-1985	3
4-5	2BC07020902	Blade	1
4-6	BZ4DC001019	Nut M10 /Gb/889.1-200	1
4-7	2BC02022001	Cover	1
4-8	2BC02021903	Holder B	1
4-9	2BC07020901	Balde	1
4-10	2BC02021902	Holder A	1
4-11	BZ3BJCM0512	Nutm5*12 /Gb/T818-2000	3
4-12	2BC02020303	Cover	1
5	2BCS1686	Gearbox Assembly	1
5-1	BZ6AE32	Snap Ring \varnothing 32 /Gb/T893.1-1986	1
5-2	BZ7AE6002RS	Bearing 6202Rs /Gb/T276-1994	1
5-3	2BC02020101	Shaft	1
5-4	2BC02020702	Pinion	1
5-5	2BC02041401	Gear Case	1
5-6	BZ3GJCM0612	Bolt M6X12 /Gb/T70.1-2000	1
5-7	BZ3GJCM0616	Bolt M6X16 /Gb/T70.1-2000	1

Spare parts list for RPMT520 Transmission			
Pozice	Obj.číslo	Popis	Množství
5-8	BZ3GJCM0525	Bolt M5X25 /Gb/T70.1-2000	1
5-9	BZ3GJCM0535	Bolt M5X35 /Gb/T70.1-2000	1
5-10	2BC07020701	Pinion	1
5-11	BZ6BE10	Snap Ring Φ 10 /Gb/T894.1-1986	1
5-12	BZ6AE26	Snap Ring Φ 26 /Gb/T894.1-1986	1
5-13	BZ7AE6000RS	Bearing 6000Rs /Gb/T276-1994	3
5-14	BZ4CB05	Nut M5 /Gb/889.2-2000	1
6	2BC06020100	Cam. Tap. Head	1
6-1	BZ4AB10	Nut M10 /Gb/T6171-2000	1
6-2	2BC02000403	Inner Spool Cap	1
6-3	BZ5AF28-39	Washer	1
6-4	2BC02020502	Spring	1
6-5	BZ5AF28-39	Washer	1
6-6	2BC02001002	String	1
6-7	2BC02001902	Inner Spool	1
6-8	2BC02000404	Inner Spool Cap	1
7	2DGR15669	Handle Assy	1
7-1	2BC07000801	P Type Handle	1
7-2	BZ3GJCM0530	Bolt M5X30 /Gb/T70.1-2000	4
7-3	2BC07070301	Inner Spool Cap	1
7-4	BZ4CB05	Nut M5 Gb/889.2-2000	4
7-5	2BC07000802	P Type Handle	1
8	2BCD4565633	Shoulder Belt Assy	1
8-1	2BC02040801	Shoulder Belt	1
8-2	2BC12000501	Hanger	1
8-3	BZ4CB05	Nut M5 /Gb/889.2-2000	1
8-4	2BC12000501	Hanger Bracket	1
8-5	BZ3GJCM0525	Bolt M5X25 /Gb/T70.1-2000	1
9	2CBR456862	Switch Assy	1
9-1	2GT02000801	Right Handle	1
9-2	BZ3BXE03516	Screw St /Gb845-1985	4
9-3	BZ3BZEV4808	Screw St /Gb845-1985	2
9-4	2GT02000802	Left Handle	1
9-5	2GT02000507	Bellows Pipe	1
9-6	2BC06081601	Throttle Cable	1
9-7	2GT02030601	Stop Switch	1
9-8	BZ3EZB00312	Screw St /Gb845-1985	2
9-9	2GT02001302	Safty Lever	1
9-10	2BC06020601	Spring	1
9-11	2GT02001303	Liberate Shaft	1
9-12	2GT02020502	Spring	1
9-13	2GT02001301	Trigger	1
9-14	2GT07030201	Flameout Cable	2
9-15	2BC06030801	Connect	2

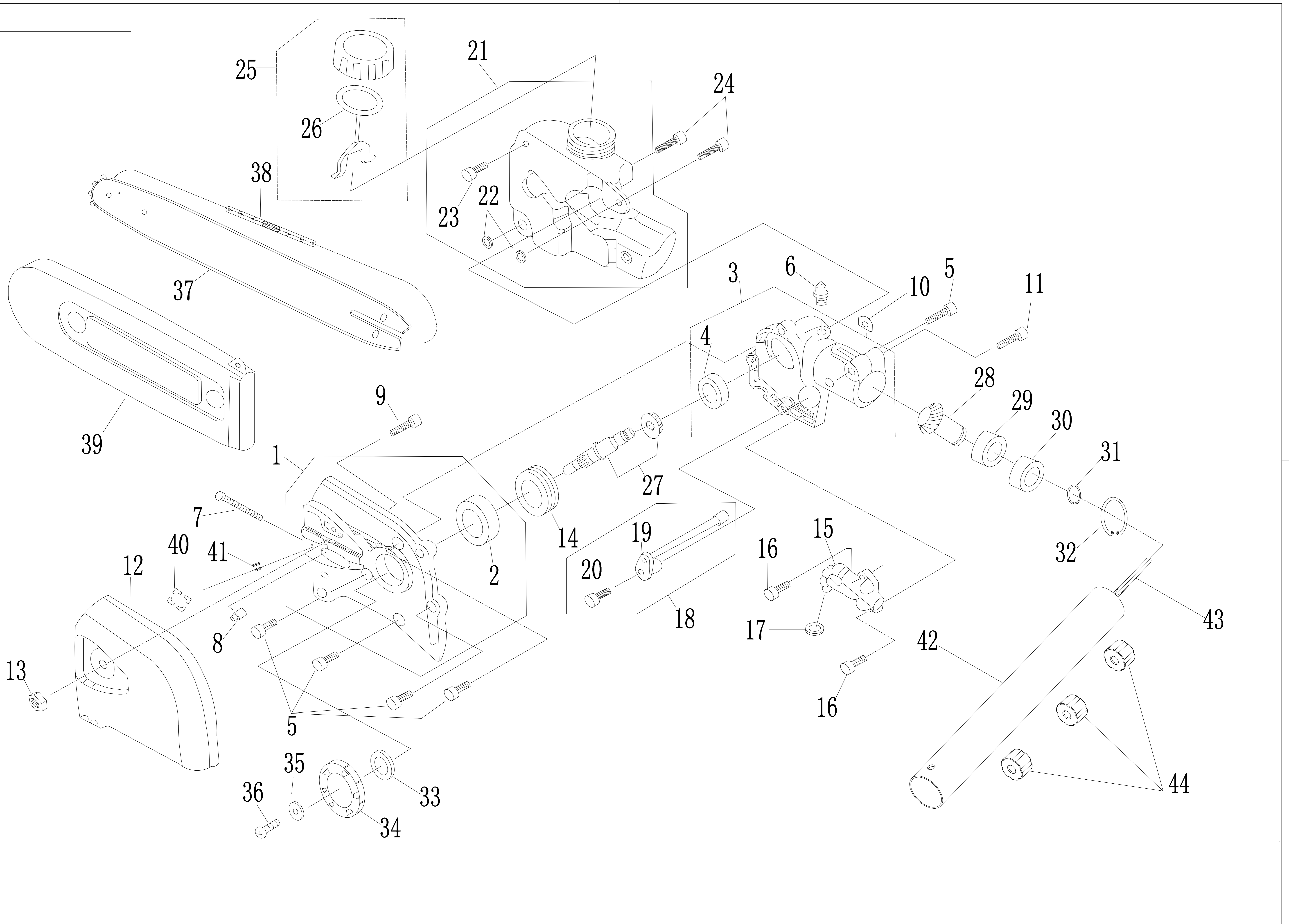

RPMT 520 Chain saw head			
Pozice	Obj.číslo	Popis	Množství
1	2BC719901	Gear Case Left	1
2	2BC719902	Bearing	1
3	2BC719903	Gear Case Right	1
4	2BC719904	Bearing	2
5	2BC719905	Blot	5
6	2BC719906	Oil Screw	1
7	2BC719907	Adjustable Screw	1
8	2BC719908	Nut	1
9	2BC719909	Blot	1
10	2BC719910	Washer	1
11	2BC719911	Blot	1
12	2BC719912	Bar Cover	1
13	2BC719913	Nut	1
14	2BC719914	Turbine	1
15	2BC719915	Oil Pump	1
16	2BC719916	Blot	2
17	2BC719917	Washer	1
18	2BC719918	Oil Vitas	1
19	2BC719919	Oil Vita	1
20	2BC719920	Strainer	1
21	2BC719921	Oil Tank	1
22	2BC719922	Gasket	2
23	2BC719923	Valve	1
24	2BC719924	Blot	2
25	2BC719925	Tank Cover	1
26	2BC719926	Cover Gasket	1
27	2BC719927	Driving Gear	1
28	2BC719928	Gear	1
29	2BC719929	Bearing	1
30	2BC719930	Bearing	1
31	2BC719931	Collar	1
32	2BC719932	Collar	1
33	2BC719933	Gasket	1
34	2BC719934	Driving Annulus	1
35	2BC719935	Washer	1
36	2BC719936	Blot	1
37	2BC719937	Bar 10"	1
38	2BC719938	Chain	1
39	2BC719939	Bar Cover	1
40	2BC719940	Rubber Pad	4
41	2BC719941	Pin	2
42	2BC719942	Pipe	1
43	2BC719943	Shaft	1
44	2BC719944	Bush	3

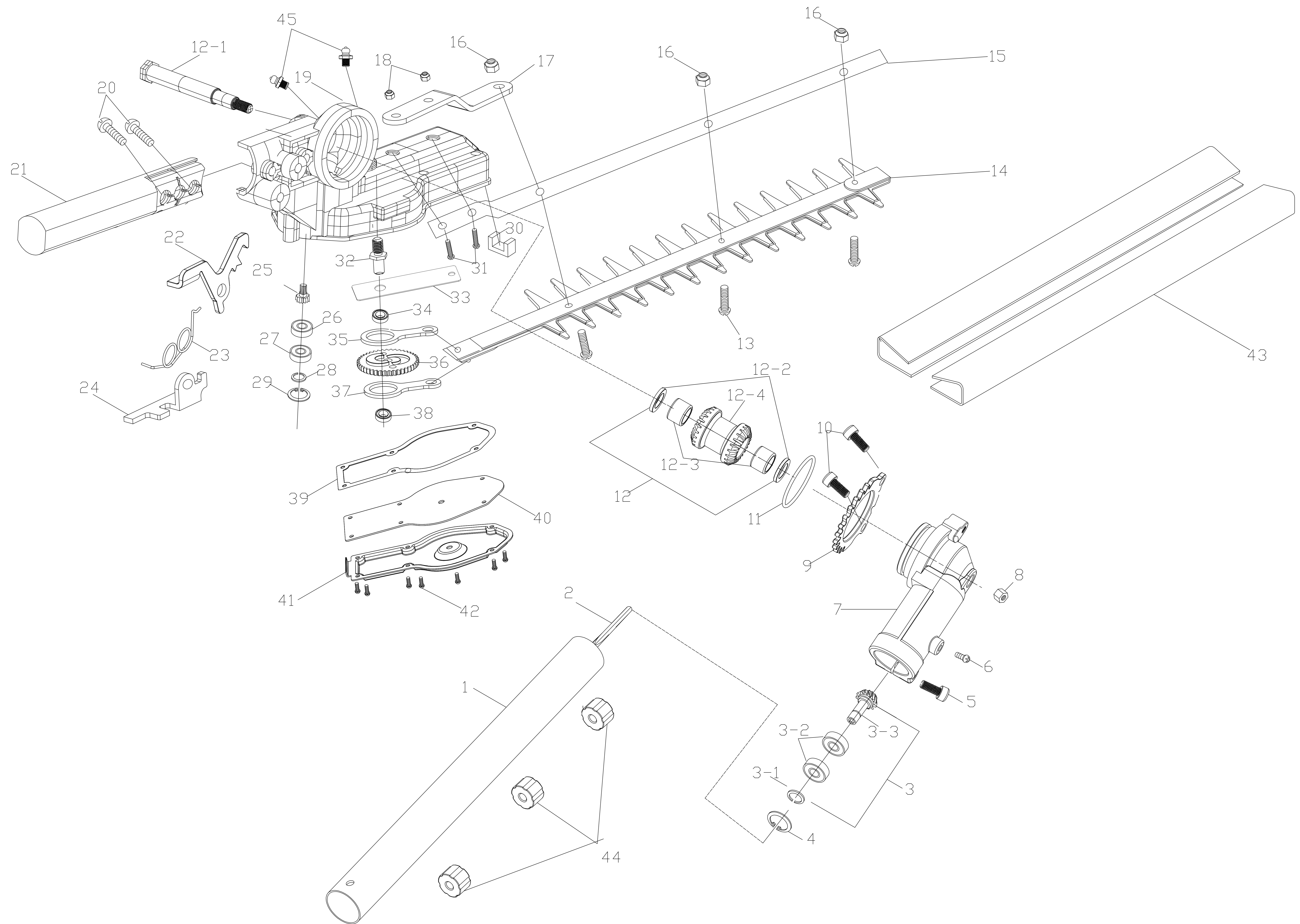

RPMT 520 Hedge trimmer head			
Pozice	Obj.číslo	Popis	Množství
1	2BH719901	Pipe	1
2	2BH719902	Shaft	1
3	2BH719903	Input Axe Assy	1
3-1	2BH719903-1	Clap Spring	2
3-2	2BH719903-2	Alxetree	1
3-3	2BH719903-3	Input Shaft	1
4	2BH719904	Clap Shaft	1
5	2BH719905	Blot	1
6	2BH719906	Blot	1
7	2BH719907	Pipe Seating	1
8	2BH719908	Nut	1
9	2BH719909	Ratchet Wheel	1
10	2BH719910	Blot	2
11	2BH719911	Seal Round	1
12	2BH719912	Middle Shaft Assy	1
12-1	2BH719912-1	Middle Shaft	1
12-2	2BH719912-2	Washer	2
12-3	2BH719912-3	Needle Bearing	2
12-4	2BH719912-4	Gear	1
13	2BH719913	Blot	3
14	2BH719914	Blade Assy	2
15	2BH719915	Protect Bar	1
16	2BH719916	Nut	3
17	2BH719917	Sustain Bar	1
18	2BH719918	Nut	2
19	2BH719919	Gear Case	1
20	2BH719920	Blot	2
21	2BH719921	Handle	1
22	2BH719922	Trigger	1
23	2BH719923	Spring	1
24	2BH719924	Trigger Rocke	1
25	2BH719925	Gear	1
26	2BH719926	Alxetree	1
27	2BH719927	Alxetree	1
28	2BH719928	Clap Spring	1
29	2BH719929	Clap Spring	1
30	2BH719930	Wool Felt	1
31	2BH719931	Blot	2
32	2BH719932	Gear Shaft	1
33	2BH719933	Washer	1
34	2BH719934	Wearable Washer	1
35	2BH719935	Connecting Rod	1
36	2BH719936	Driven Gear	1

RPMT 520 Hedge trimmer head			
Pozice	Obj.číslo	Popis	Množství
37	2BH719937	Connecting Rod	1
38	2BH719938	Wearable Washer	1
39	2BH719939	Washer	1
40	2BH719940	Washer (Blown)	1
41	2BH719941	Cover (Down)	1
42	2BH719942	Blot	7
43	2BH719943	Blade Cover	2
44	2BH719944	Bush	3
45	2BH719945	Grease Nipple	2